

Basic instructions

Recommended installation

The products may only be used for the intended purpose and under safe and fault-free conditions.

- Correct usage also covers observance of this instruction manual.
- Any use not in accordance with the prescribed usage shall be regarded as incorrect usage, and may lead to product failure.
- For proper installation of Oetiker PEX series clamps, use calibrated genuine Oetiker installation tools.
- For ratchet pincer maintenance, care and calibration, reference the complete Calibration Procedures supplied with Tool or reference sections 3.1, 3.2 and 3.3 of this instruction manual.

1. **3-Handle Ratchet Pincer** (Fig. 1)
Sargent Tools #9253 SCP

- Includes GO/NO-GO gauge
- Can be calibrated
- Lightweight for easy handling
- Heavy-duty professional grade tool
- Single handed installation

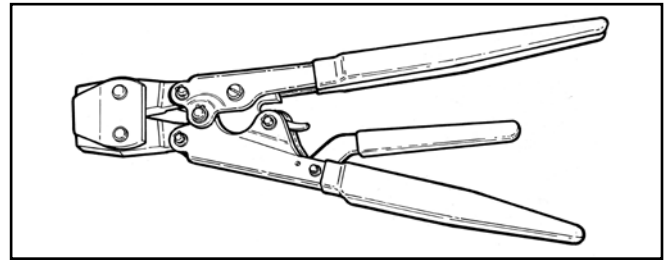

Fig. 1: 9253 SCP

2. **2-Handle Ratchet Pincer** (Fig. 2)
Sargent Tools #9252 SCP

- Includes GO/NO-GO Gauge
- Can be calibrated
- Lightweight for easy handling
- Heavy-duty professional grade tool

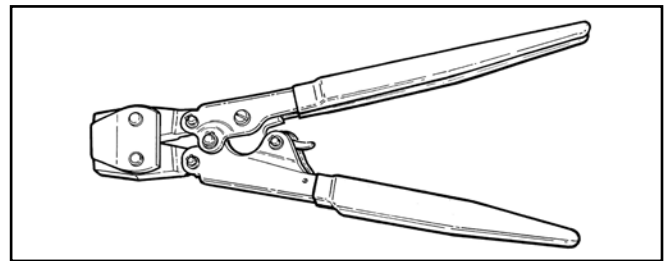

Fig. 2: 9252 SCP

Clamp installation instructions

1. Per ASTM F2098, insert fitting into tubing until shoulder or tube stop contacts end of tubing. Position clamp within 1/8" to 1/4" (3.2 to 6.4 mm) of tube end. (Fig. 3)

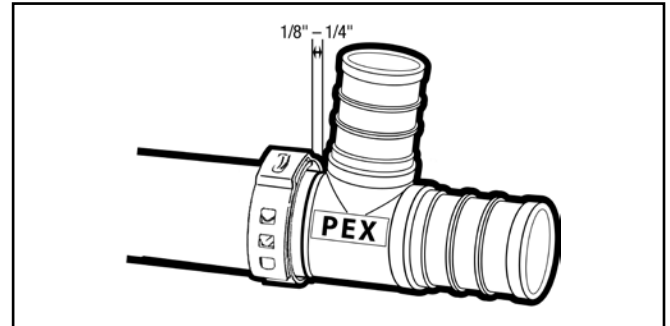

Fig. 3: Insert fitting/position clamp

2. Close clamp ear with tool, tool will not release until clamp is fully closed. (Fig. 4)

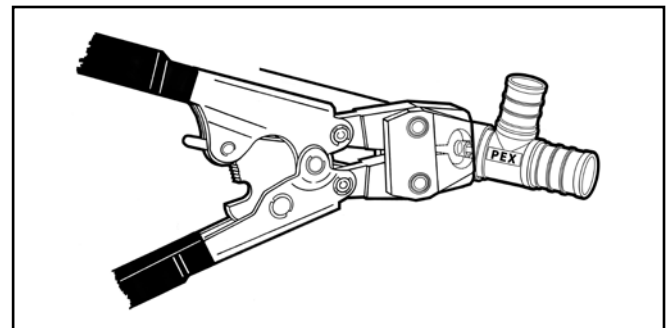

Fig. 4: Close clamp ear with tool

3. IMPORTANT: For proper installation of Oetiker PEX series clamps, full ear closure is required. Visually inspect clamp for correct closed ear form. (Fig. 5)

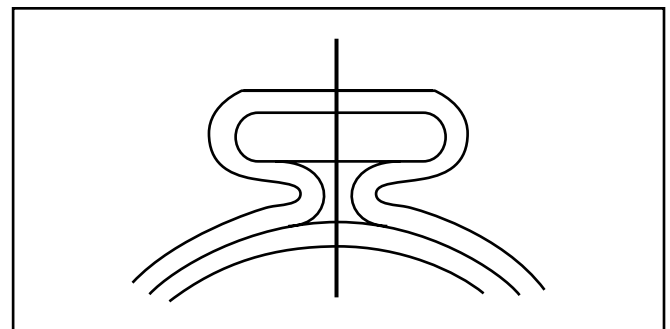

Fig. 5: Full ear closure required

Assembly notice

NOTICE

- ▶ For the correct assembly of Oetiker StepLess® 167 PEX clamps, the clamps must be completely closed.
- ▶ Genuine Oetiker Hand Installation Pincers with ratchet mechanism will release only when clamp has fully closed.

Warning notice: clamp installations

WARNING

- ▶ In high chloride water conditions, use only plastic fittings.
- ▶ Do not install in contact with concrete
- ▶ Use only ASTM F1807 or F2159 insert fittings with OETIKER clamps.
- ▶ Failure to observe the above warnings may result in property damage.

International standards

- Clamps conform to ASTM¹ F2098 for use with ASTM F1807 and F2159 insert fittings and ASTM F876 PEX² tubing. For additional information, please refer to ASTM International Standards Worldwide.
- Complies with NSF³ product listing cNSFus-PW. For additional information, please refer to the NSF organization.

¹ ASTM = American Society for Testing and Materials

² PEX = Polyethylene cross-linked

³ NSF = National Sanitation Foundation

Pincer Tools for Oetiker StepLess® Ear Clamps 167 for PEX

Re-calibrating tools for: Tools nos. 9253 SCP and 9252 SCP

Re-calibration instructions on this page are specific for Ratchet Pincer Tool nos. 9253 SCP and 9252 SCP

1. Using a straight blade screw driver, loosen adjustment nut (Fig. 11).
2. Close handles to stop point and place GO/NO-GO Gauge into jaw gap.
3. Using a straight blade screwdriver, rotate eccentric stud (Fig. 12) counter-clockwise until jaws contact the GO/NO-GO Gauge before the NO-GO area of the Gauge.
4. Using a straight blade screwdriver, tighten the adjustment nut (Fig. 13).
5. Check tool calibration daily.

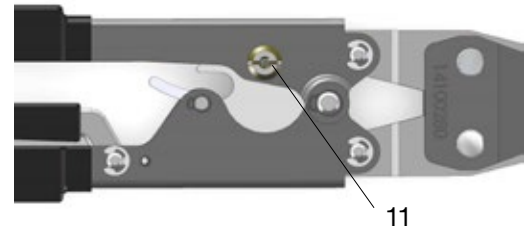

Fig. 11: Adjustment nut

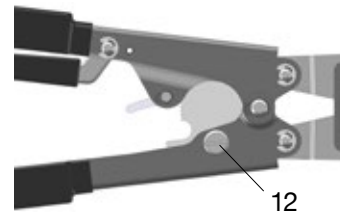

Fig. 12: Eccentric Stud

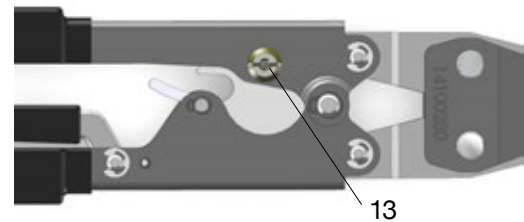

Fig. 13: Adjustment nut

Tool maintenance

- Do not use the Ratchet Tools for any purpose other than to assemble clamps. Use other than intended may damage the tool and void warranty.
- Lubricate the tool head, spring and ratchet mechanism once per every 30 days with a light lubricating oil (if tool operation becomes sluggish at any time lubricate prior to further use).
- Clean tool periodically to remove rust and dirt. Rust or dirt build-up will interfere with tool operation and void warranty coverage. Lubricate all parts after cleaning to provide a light protective coating of oil.

Tool warranty

When properly maintained and used as intended the Ratchet Tools are warranted against materials and manufacturing defects for a period of one year from date of purchase. This warranty does not cover defects or damage arising from improper storage or handling, ordinary wear and tear, misuse, abuse, accident or use with unauthorized product or parts. Liability is limited to repair or replacement of product or component part which is determined defective as covered by this warranty.